

Our access floor boxes are ordered as a single assembly - 'Frame & Lid'. Select from our wide range of serviced power and unserviced data options. Accessory plates are common to most ranges - one piece, individual, screed & stainless floor boxes & slab floor boxes

3 compartment version for one piece, individual, screed & stainless floor boxes & slab boxes 100mm wide (Finish – Lt. Grey Paint RAL7035)

Plate sizes - 100mm x 175mm Can be only fitted in 3 compartment floor and slab boxes

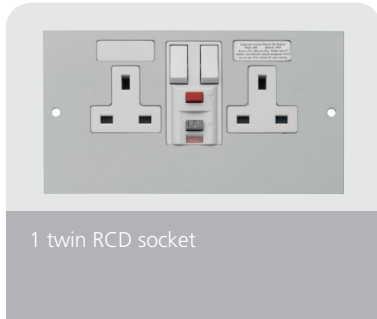

1 twin RCD socket

Code	Description
PP3291	3 Compartment Version

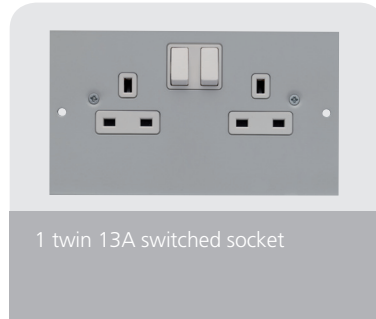

1 twin 13A switched socket

Code	Description
PCP301	3 Compartment Version



1 twin 13A unswitched socket

Code	Description
PCP302	3 Compartment Version

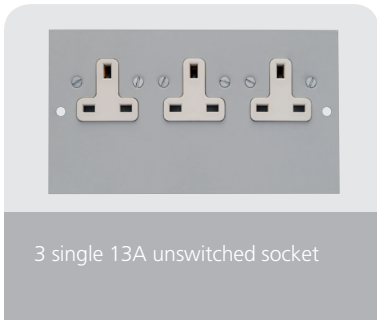

3 single 13A unswitched socket

Code	Description
PCP3003	3 Compartment Version

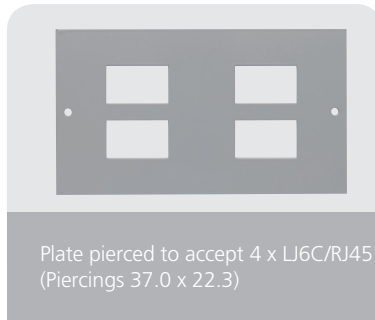

Plate pierced to accept 4 x RJ45 (Piercings 37.0 x 22.3)

Code	Description
PV304	3 Compartment Version

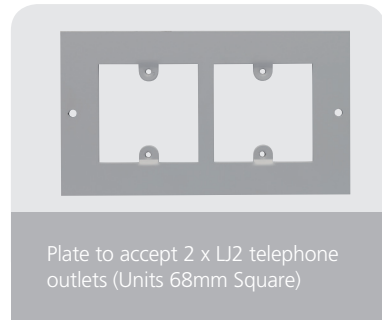

Plate to accept 2 x RJ2 telephone outlets (Units 68mm Square)

Code	Description
PV305	3 Compartment Version



Standard BS 1363 2 gang piercing

Code	Description
PM307	3 Compartment Version

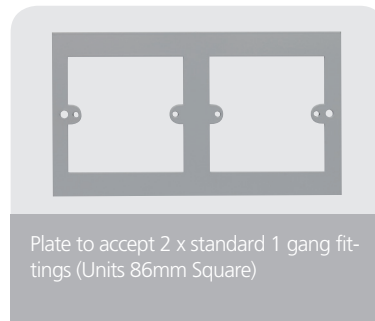

Plate to accept 2 x standard 1 gang fittings (Units 86mm Square)

Code	Description
PV311	3 Compartment Version

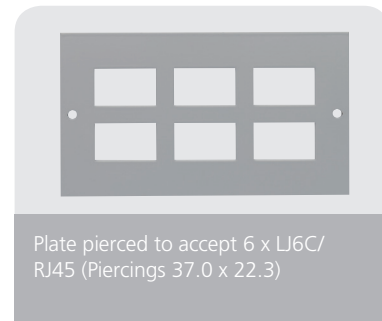
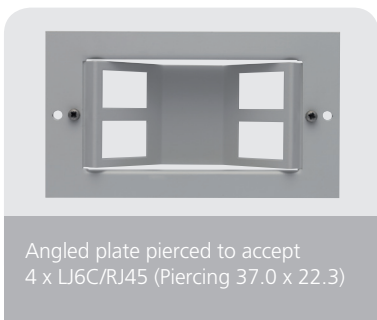

Plate pierced to accept 6 x RJ45 (Piercings 37.0 x 22.3)

Code	Description
PV342	3 Compartment Version



Angled plate pierced to accept 4 x RJ45 (Piercing 37.0 x 22.3)

Code	Description
PDV397	3 Compartment Version

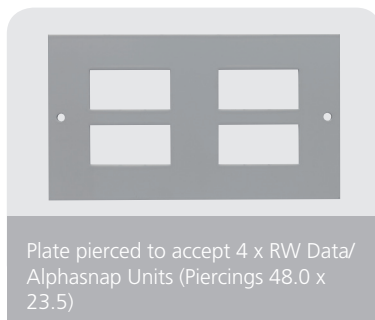

Plate pierced to accept 4 x RJ45 Data/Alphasnap Units (Piercings 48.0 x 23.5)

Code	Description
PD3107	3 Compartment Version

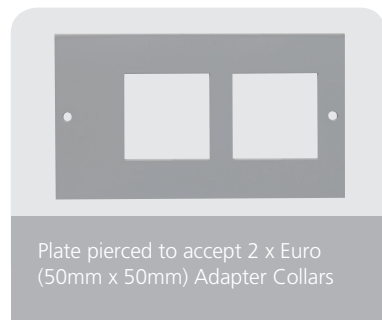

Plate pierced to accept 2 x Euro (50mm x 50mm) Adapter Collars

Code	Description
PD331	3 Compartment Version

Also available: 3 Compartment Blank Plate - Code: PB306

sales line: +44 (0)1995 640844

Accessory plates

4 compartment version for one piece, individual, screed & stainless floor boxes & slab boxes
75mm wide (Finish – Lt. Grey Paint RAL7035)

Can be fitted in 1, 2 and 4 compartment slab boxes and 2, 4 compartment floor boxes

Plate sizes - 75mm x 175mm

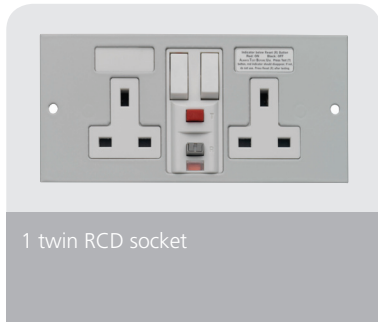

1 twin RCD socket

Code	Description
PP4291	4 Compartment Version

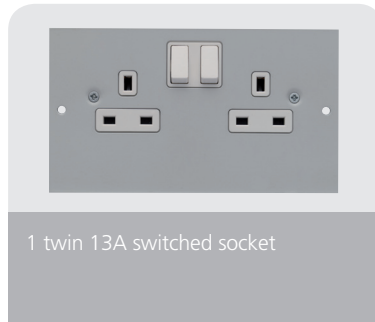

1 twin 13A switched socket

Code	Description
PCP401	4 Compartment Version



1 twin 13A unswitched socket

Code	Description
PCP402	4 Compartment Version

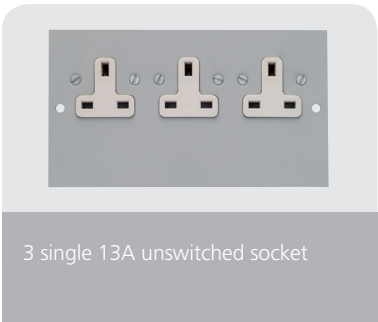

3 single 13A unswitched socket

Code	Description
PCP4003	4 Compartment Version



Plate pierced to accept 4 x LJ6C/RJ45
(Piercings 37.0 x 22.3)

Code	Description
PV404	4 Compartment Version

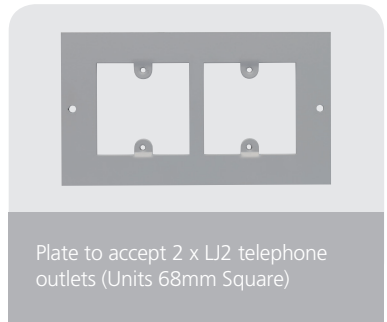
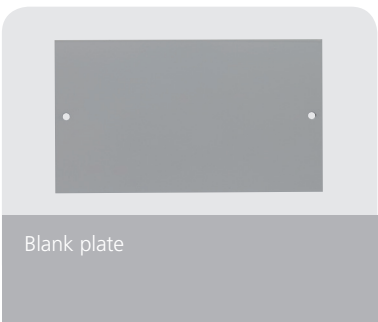

Plate to accept 2 x LJ2 telephone
outlets (Units 68mm Square)

Code	Description
PV405	4 Compartment Version



Blank plate

Code	Description
PB406	4 Compartment Version

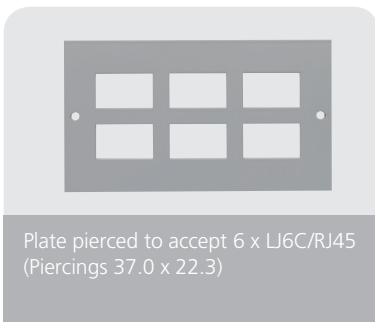

Plate pierced to accept 6 x LJ6C/RJ45
(Piercings 37.0 x 22.3)

Code	Description
PV442	4 Compartment Version



Angled plate pierced to accept
4 x LJ6C/RJ45 (Piercing 37.0 x 22.3)

Code	Description
PDV497	4 Compartment Version

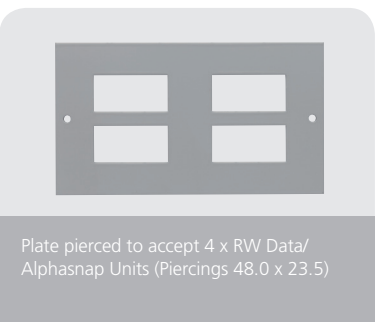

Plate pierced to accept 4 x RW Data/
Alphasnap Units (Piercings 48.0 x 23.5)

Code	Description
PD4107	4 Compartment Version

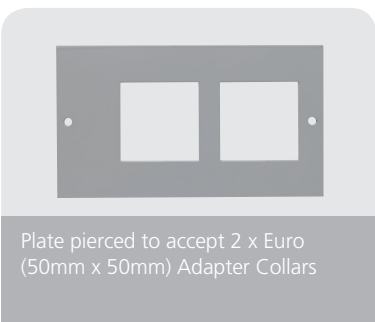

Plate pierced to accept 2 x Euro
(50mm x 50mm) Adapter Collars

Code	Description
PD431	4 Compartment Version

Sockets are available in clean earth versions. All twin sockets have a dual earth facility to enable compliance to BS 7671:2008 Regulation 543.7.1.4.

If the accessory plate you require is not included in the most widely used selection as shown, please ring technical sales for further information.

NB. 3 & 4 compartment accessory plates cannot be mixed in boxes

