

Dimensions

Designed to fit onto desks with 22-32mm thickness with the included clamp.

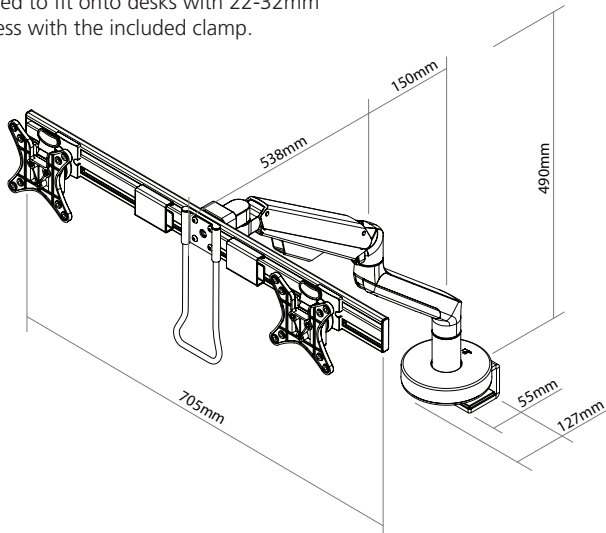

Mounting the base to the desk

Use the supplied M8x20mm grub screws in the clamp if more thread is required

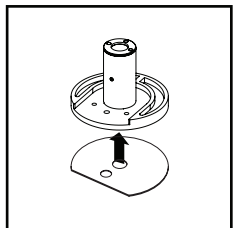

Ensure the EVA pad is applied to the bottom of the base to protect the desk surface.

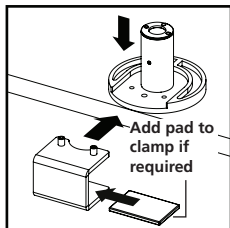

Place base on desk with recess facing the edge. Offer up the clamp to the base as shown.

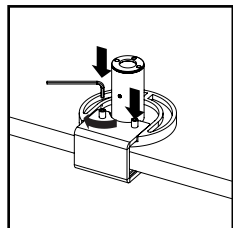

Use 4mm Allen key to tighten the 2x grub screws in the clamp into the base.

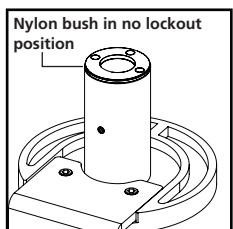

The nylon bush can be removed, flipped and refitted to remove/apply the 180° lockout.

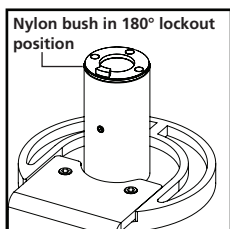

Flip the bush over so the protrusion faces upwards to apply the 180° lockout as shown.

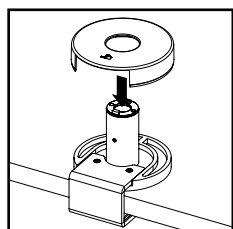

Place the clamp cover over the base with the recess facing the desk edge. No fixing required.

Contents

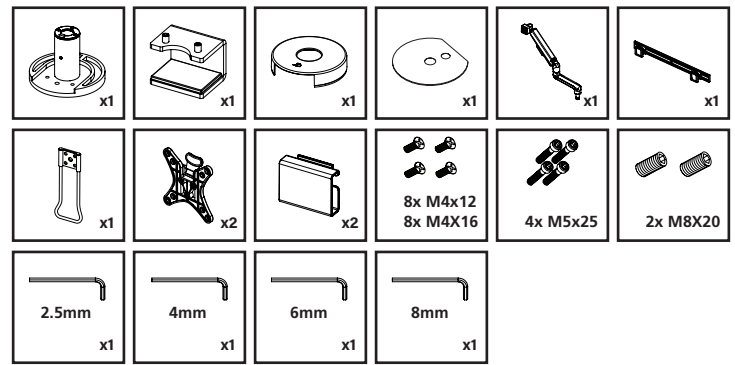

Installing the arm and horizontal rail

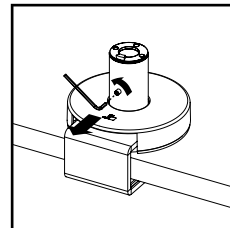

Use 2.5mm Allen key to loosen grub screw and allow arm assembly to drop into base stem.

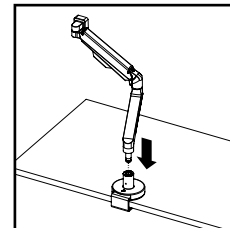

Carefully insert the pin at the bottom of the arm assembly into the base stem.

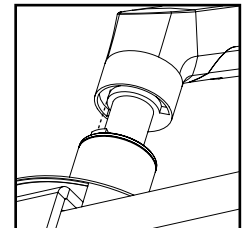

If 180° lockout is required, ensure bush protrusion sits in recess at bottom of the arm.

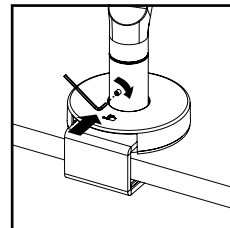

Tighten the grub screw to secure the arm assembly to the base. Do not overtighten.

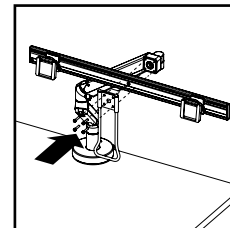

Use 4x M5x25mm bolts to fix the handle and horizontal rail to the head of the arm.

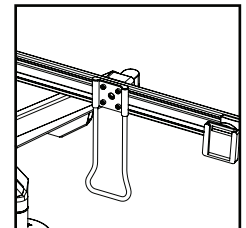

The rail is now fully assembled and ready for the monitors to be installed.

Installing monitors

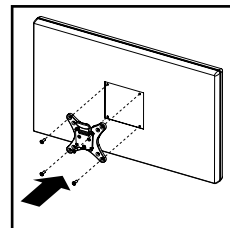

Fix quick release VESA in place with supplied fixings. 4x M4x12/16mm CSK pozi screws.

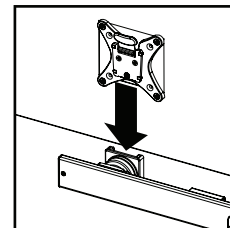

Align the raised square section on the VESA with the recess on the rail mount.

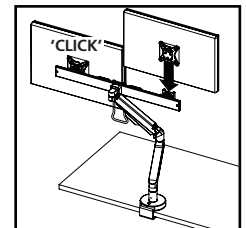

Lower the monitor onto the rail mount until it clicks into place. Repeat for the second monitor.

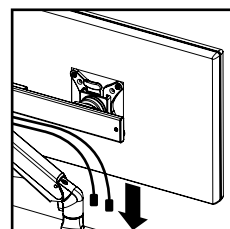

To remove the monitors, start by disconnecting any cables.

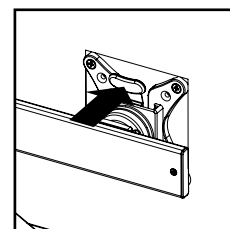

Depress the lever at the top of the VESA to release it from the rail mount. Lift up monitor.

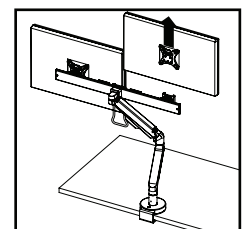

The arm may try to spring up as the weight is removed. Guide the arm to prevent this.

Cable management

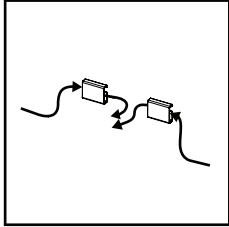

Feed cables from monitors through the cable clips as shown.

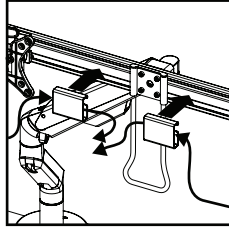

Insert the cable clips with cables into the rail by gently flexing and snapping into place.

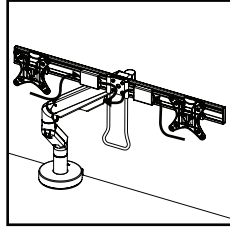

Neaten up the cables if necessary, ready to feed the cables to the arm assembly.

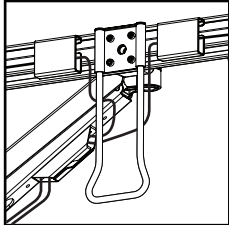

Feed the cables through the built in cable clip on the upper arm assembly as shown.

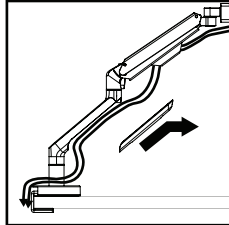

Remove the plastic cover on the lower arm assembly by sliding it up and away from the arm.

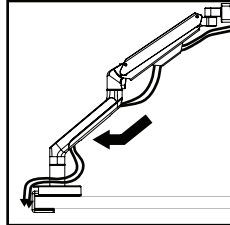

Position the cables inside the cover and slide back into place on the arm.

Arm adjustment

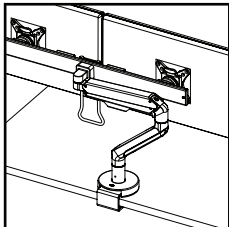

Adjust the monitor arm with the upper section parallel to the desk surface as shown.

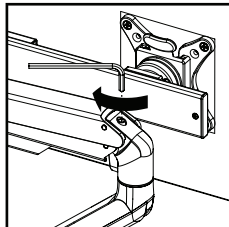

Use 6mm Allen key to turn bolt clockwise for heavy monitors. Use free hand to guide the arm.

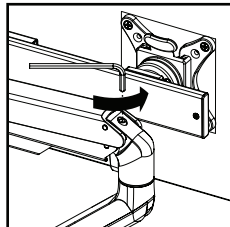

Use 6mm Allen key to turn bolt anti clockwise for lighter monitors. Use free hand to guide arm.

Rail angle adjustment

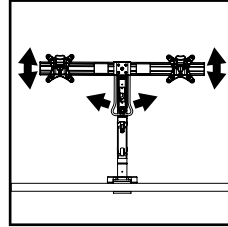

Use the central handle to pivot the rail left or right by a small amount.

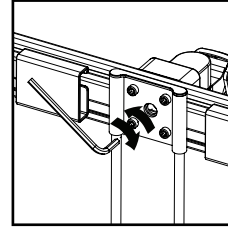

If necessary, the level of friction can be controlled using the 6mm Allen key on the central bolt.

Rail mount adjustment

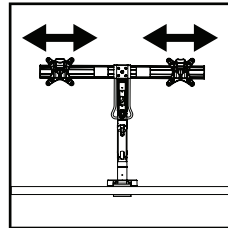

Adjust both mounts if necessary to achieve the optimum placement of your monitors.

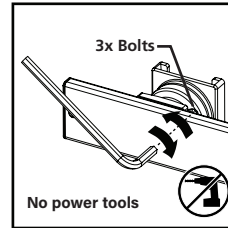

For further adjustment, use the supplied 4mm Allen key to loosen or tighten the 3x bolts.

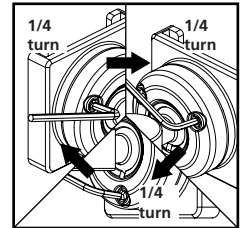

Bolts must be tightened equally, alternating between each until they are all fully tightened.

Supported load

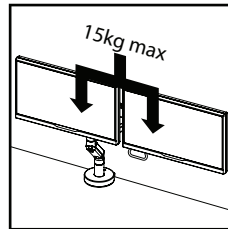

The maximum combined load of two monitors on the rail is 15kg.

Additional information

Safety

- Fix the clamp of the monitor arm to a suitable solid worksurface that is capable of supporting the arm and maximum loading of 15kg.
- Product to be used only for the intended purpose of supporting certain display equipment in an office environment.
- Installation is to be carried out in accordance with relevant Health & Safety regulations and only to be carried out by a skilled or competent person.
- The installation should be installed to comply with the relevant national standards and be inspected and tested prior to being put into service (in the UK BS 7671 Wiring Regulations or BS 6396 Office and Educational Systems Best Practice).
- Isolate the supply before installation or repositioning. Any locking mechanisms must be used and fully engaged.
- Do not misuse, dismantle or re-configure the product because doing so will invalidate the warranty.

Standards

- Refer to the Declaration of Conformity.

Product care

- To maintain the longevity of the arm's gas strut and correct function, regularly adjust the arm through it's range of motion when possible.
- Clean using a dry cloth. No abrasives or solvents to be used on the product.
- Do not drop or expose to moisture.

