



Capsule

Workplace Power



5 Year
Warranty



100%
Recyclable



DESCRIPTION

A fixed format on-desk power module offering 2x UK sockets with individual LED switches, 3A resettable thermal circuit breakers and a dual port USB adaptive fast charger for charging laptops, tablets and smart phones. Capsule is equipped with Smart PPS Fast Charging for maximum performance.

KEY FEATURES

1. 2x UK sockets with individual LED switches and 3A resettable thermal circuit breakers
2. A choice of USB Type A and C socket options with LED indicators that illuminate when in use
3. 2x keystone blanks that can be populated with a choice of data keystones
4. Fitted with 1.5m cable to 3-pole GST male connector (starter lead sold separately)
5. Supplied with c-clamp fixing to fit desk thicknesses between 11mm and 30mm
6. Available in black and white



DIMENSIONS

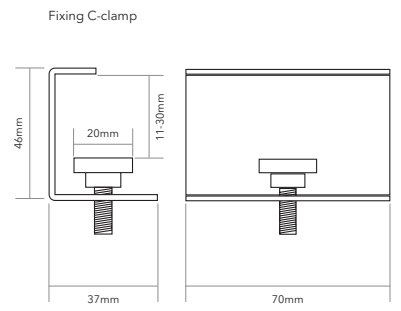
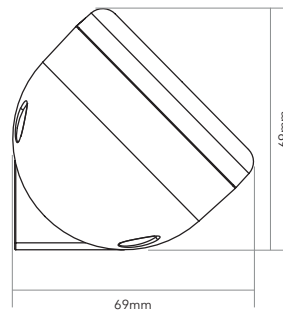
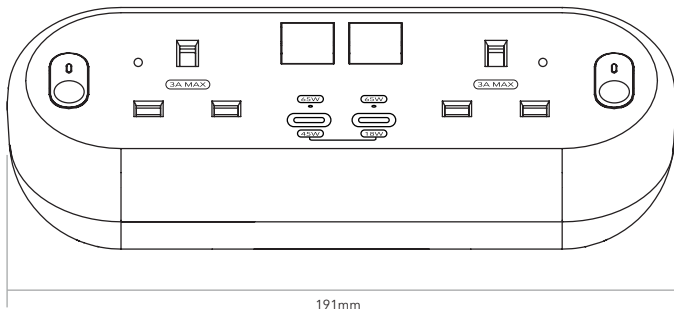

Fitting requires a 4mm Allen key (not supplied).

USB CHARGING PROTOCOLS

Capsule 'handshakes' with the device to provide safe and efficient charging. The dual port Type A and C USB charging ports are designed to adapt to the way they are used, offering maximum power output when used alone, whilst sharing the available power when used together. They are equipped with Smart PPS Fast Charging for maximum performance.

30W TYPE A&C USB

Usage Scenario	USB-C (#1) Output	USB-A (#2) Output	Max Output
USB-C Alone	18W	-	18W
USB-A Alone	-	18W	18W
USB-A + C Together	18W	12W	30W

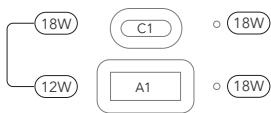

- Port C1: PD3.0; QC3.0; Apple2.4A; Samsung AFC; HUAWEI FCP; BC1.2; DCP 1.5A
- Port A1: QC3.0; Apple2.4A; Samsung AFC; Huawei FCP; BC1.2; DCP 1.5A

65W TYPE A&C USB

Usage Scenario	USB-C (#1) Output	USB-C (#2) Output	Max Output
USB-C Alone	65W	-	65W
USB-A Alone	-	18W	18W
USB-A + C Together	45W	18W	65W

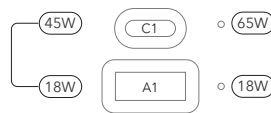

- Port C1: PD3.0 (with PPS); QC3.0; Apple2.4A; Samsung AFC; HUAWEI FCP; BC1.2; DCP 1.5A
- Port A1: QC3.0; Apple2.4A; Samsung AFC; Huawei FCP; BC1.2; DCP 1.5A

65W TYPE C&C USB

Usage Scenario	USB-C (#1) Output	USB-C (#2) Output	Max Output
USB-C (1) Alone	65W	-	65W
USB-C (2) Alone	-	65W	65W
USB-C (1 + 2) Together	45W	18W	65W

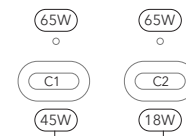

- Port C1: PD3.0 (with PPS); QC3.0; Apple2.4A; Samsung AFC; HUAWEI FCP; BC1.2; DCP 1.5A
- Port C2: PD3.0; QC3.0; Apple2.4A; Samsung AFC; HUAWEI FCP; BC1.2; DCP 1.5A

MATERIAL COMPOSITION

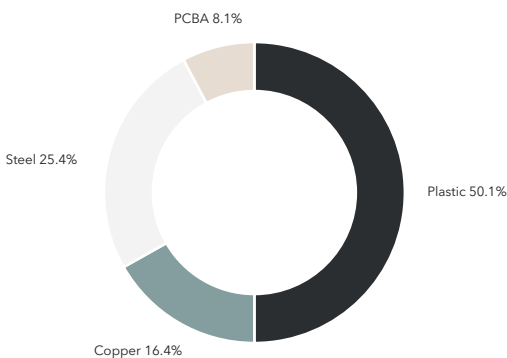

ORDERING

30W TYPE A&C USB

Part Number	Description	Cable	Colour
72J0028	2x Power, 1x Dual Port Type A and C USB Charger, 2x Individual On/Off Switches, 2x 3A Resettable Thermal Circuit Breakers	1.5m	Black
72J0029	2x Power, 1x Dual Port Type A and C USB Charger, 2x Individual On/Off Switches, 2x 3A Resettable Thermal Circuit Breakers	1.5m	White

65W TYPE A&C USB

Part Number	Description	Cable	Colour
72J0030	2x Power, 1x Dual Port Type A and C USB Charger, 2x Individual On/Off Switches, 2x 3A Resettable Thermal Circuit Breakers	1.5m	Black
72J0031	2x Power, 1x Dual Port Type A and C USB Charger, 2x Individual On/Off Switches, 2x 3A Resettable Thermal Circuit Breakers	1.5m	White

65W TYPE C&C USB

Part Number	Description	Cable	Colour
72J0034	2x Power, 1x Dual Port Type C USB Charger, 2x Individual On/Off Switches, 2x 3A Resettable Thermal Circuit Breakers	1.5m	Black
72J0035	2x Power, 1x Dual Port Type C USB Charger, 2x Individual On/Off Switches, 2x 3A Resettable Thermal Circuit Breakers	1.5m	White



Website

