

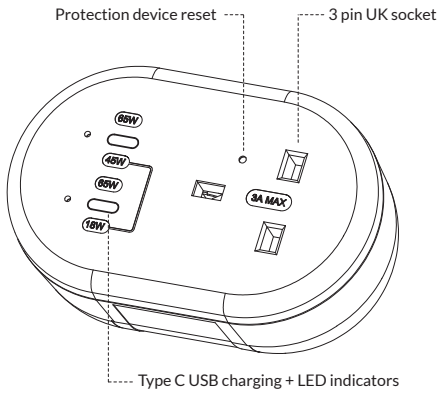

Caplet. Installation, user and care guide.



Caplet is available in USB type A and C, and dual USB type C versions. Models shown in this guide are for illustration purposes only.

Safety warning

For your safety, this product must be installed in accordance with local Building Regulations. If in any doubt, or where required by the law, consult a competent person who is registered with an electrical self-certification scheme. Installation should be in accordance with the latest edition of the IET regulations (BS 7671). If the unit is being installed in an office environment by means of a 13A plug please ensure BS6396 is adhered to.

Please read carefully and use in accordance with these safety instructions. Before commencing any electrical work ensure the supply is isolated at the mains. To prevent fire hazard always use a power lead of the correct rating and type for the application.

Warning: Do not exceed the load rating of this device as stated on the rear of the product. Incorrect use could lead to risk of electrocution.

Built-in protection

This product has been designed to protect connected equipment as well as end user. Each socket outlet has protection in the form of a 3A resettable thermal fuse that detects overloads or any defective equipment that may be connected.

Mounting to the desk

Suitable for desks 12mm to 26mm.

Fully unscrew the M8 hex/Allen bolts and locate Caplet on edge of the desk. Offer the clamp to rear of Caplet and align to desk edge.

With the Caplet held between the clamp and desk, tighten the hex bolt securely. When inserting/removing plugs, please support the module with your free hand.

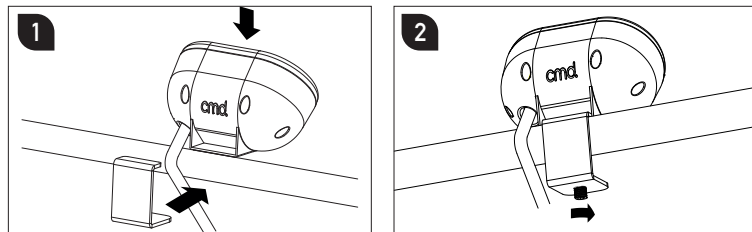

Connecting to the power supply

Push the GST connector from Caplet in to a mains starter lead or Elite power module until the locking mechanism engages with a "click" (NOT when under load or live). To disconnect; using a suitable tool release the clip and separate the connectors.

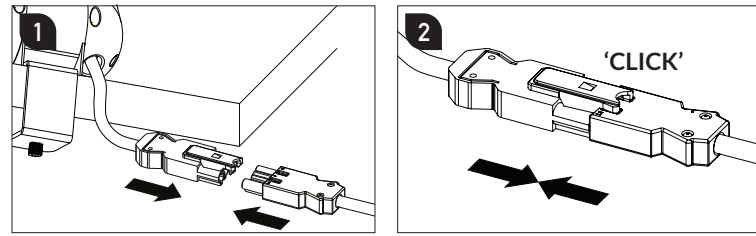

Resetting the built in protective device

If there is no power due to an overloaded socket or defective connected equipment, the built-in protection switch will operate. A red indicator will be raised and the protection switch will need resetting.

Please follow the below steps to reset the device

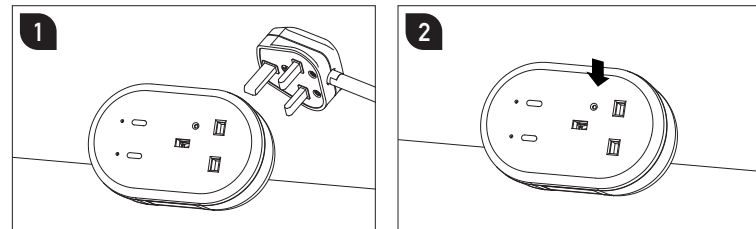

Remove the plug.

Confirm the red indicator beneath the plug has risen.

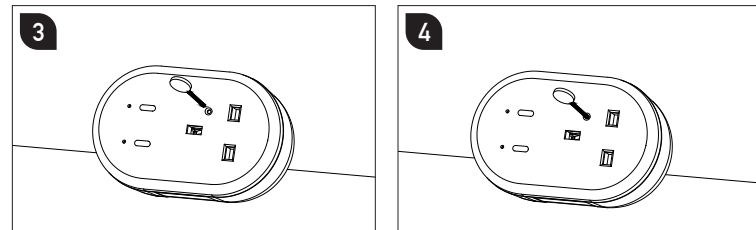

Locate a tool (not included) insert in to the reset opening.

Push until it clicks.

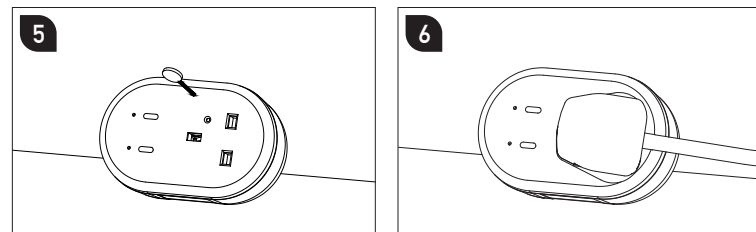

Remove tool. Investigate and rectify any faulty equipment.

Reconnect the equipment.

Technical

Voltage: 220-250V ac

Frequency: 50/60Hz

Rating: Max 3A

Standards: BS 1363-2:2023 BS EN IEC 62368-1

Connectors: 3 pole GST18 input

Cable: 1.5 metre, 1.5mm²

Mounting options: Standalone using included bracket

USB charging output: See ratings overleaf

Wiring identification

Earth = Green & Yellow

Neutral = Blue

Live = Brown

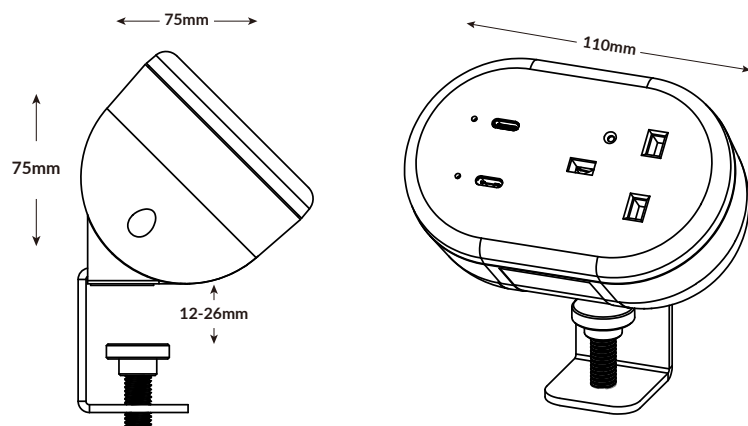

Specification	65W A + C	65W C + C
USB Output	<p>Type C: 5V DC 3.0A 15.0W MAX 9V DC 3.0A 27.0W MAX 12V DC 3.0A 36.0W MAX 15V DC 3.0A 45.0W MAX 20V DC 3.25A 65.0W MAX</p> <p>Type A: 5V DC 3.0A 15.0W MAX 9V DC 2.0A 18.0W MAX 12V DC 1.5A 18.0W MAX</p> <p>Type C + Type A: 5V DC 3.0A + 5V DC 3.0A 30.0W MIN 20V DC 2.25A + 12V DC 1.5A 63.0W MAX</p>	<p>Type C1/C2: 5V DC 3.0A 15.0W MAX 9V DC 3.0A 27.0W MAX 12V DC 3.0A 36.0W MAX 15V DC 3.0A 45.0W MAX 20V DC 3.25A 65.0W MAX</p> <p>Type C1 + Type C2: 5V DC 3.0A + 5V DC 3.0A 30.0W MIN 20V DC 2.25A + 12V DC 1.5A 63.0W MAX</p>
Input	230V~ 50Hz	230V~ 50Hz
Average active efficiency	<p>Type C: 5V DC 3.0A: >81.39% 9V DC 3.0A: >85.79% 12V DC 3.0A: >85.00% 15V DC 3.0A: >85.68% 20V DC 3.25A: >85.47%</p> <p>Type A: 5V DC 3.0A: >81.39% 9V DC 2.0A: >85.79% 12V DC 1.5A: >85.00%</p> <p>Type C + Type A: 5V DC 3.0A + 5V DC 3.0A: >81.61% 20V DC 2.25A + 12V DC 1.5A: >76.41%</p>	<p>Type C1/C2: 5V DC 3.0A: >81.39% 9V DC 3.0A: >85.79% 12V DC 3.0A: >85.00% 15V DC 3.0A: >85.68% 20V DC 3.25A: >85.47%</p> <p>Type C1 + Type C2: 5V DC 3.0A + 5V DC 3.0A: >81.61% 20V DC 2.25A + 12V DC 1.5A: >76.41%</p>
Efficiency at low load (10%)	<p>Type C: 5V DC 3.0A: >81.39% 9V DC 3.0A: >85.79% 12V DC 3.0A: >85.00% 15V DC 3.0A: >85.68% 20V DC 3.25A: >85.47%</p> <p>Type A: 5V DC 3.0A: >81.39% 9V DC 2.0A: >85.79% 12V DC 1.5A: >85.00%</p> <p>Type C + Type A: 5V DC 3.0A + 5V DC 3.0A: >81.61% 20V DC 2.25A + 12V DC 1.5A: >76.41%</p>	<p>Type C1/C2: 5V DC 3.0A: >81.39% 9V DC 3.0A: >85.79% 12V DC 3.0A: >85.00% 15V DC 3.0A: >85.68% 20V DC 3.25A: >85.47%</p> <p>Type C1 + Type C2: 5V DC 3.0A + 5V DC 3.0A: >81.61% 20V DC 2.25A + 12V DC 1.5A: >76.41%</p>
No load power consumption	1 Port <0.21W 2 Port <0.30W	1 Port <0.21W 2 Port <0.30W
Manufacturers model identifier	CP1GUAC65x	CP1GUCC65x

Service conditions

This module is only for use under the following conditions of service

- An ambient temperature range of -5°C to +40°C, with an average value not exceeding +35°C over one full day.
- An altitude not exceeding 2,000m above sea level.
- An atmosphere not subject to excessive pollution by smoke, chemical or flammable fumes; salt-laden spray; prolonged periods of high humidity or other abnormal conditions.
- Not suitable for exposure to direct radiation from the sun or other source of heat likely to raise the temperature above the designated ambient, nor may it be suitable for subjection to excessive vibration.
- Do not misuse, dismantle or re-configure the product because doing so will invalidate the warranty.
- Product to be used only for the intended purpose of distributing power and data in office and commercial environments.

Where service conditions differ from those prescribed above the advice of the manufacturer or responsible vendor should be sought.

Address / Helpline

+44 (0) 1709 829 511 or sales@cmd-ltd.com

USB operating guidelines

USB smart charging technology detects the connected devices and adjusts the charging pattern and output to suit. When the device is fully charged the USB outlets revert to low energy standby mode. Smart technology constantly monitors the charge and will shut down in the event of an overload condition, protecting the connected devices.

Total charger current can be delivered from one USB socket or divided between outputs as required. The speed of charging will depend on the battery capacity of the device and not charge output of the socket. Total output current is dictated by the specific device being charged and other external factors, including the quality of charging cable used.

The USB circuits in this socket are designed to withstand insulation resistance tests at 500V. A reading of 10MΩ minimum is typically achieved by the USB socket.

Product care

Clean using a dry cloth. No abrasives or solvents to be used on the product. Do not drop or expose to moisture.

Batch code explanation

yyWxx Manufacturing date code, year of manufacture (yy) and week of manufacture (Wxx)

Environmental protection

This product should not be disposed of with general household waste. Some chemicals contained within electronics can be harmful to health and environment.

Only dispose of electrical items in dedicated collection schemes.



CMDCAPLII-A

HEAD OFFICE

Sycamore Road, Eastwood Trading Est. Rotherham, South Yorkshire, S65 1EN
+44 (0)1709 829 511
sales@cmd-ltd.com

LONDON SHOWROOM

3 Baltic Street East London, EC1Y 0UJ
+44 (0)20 7251 7080
sales@cmd-ltd.com

SALES INTO EU

(EU) Luceco SE
C/ Bobinadora 1-5 08302 Mataró
SPAIN

cmd.